

**Input**

Rated input voltage	100 V ~ 240 V ac
Input voltage range	90 V ~ 255 V ac
Rated frequency	50~60 Hz
Frequency range	47~63 Hz
Rated input current	1.2 A RMS max.
Inrush current	50 A max. at 115 / 100 A max. at 230 V ac cool start
Power dissipation	<0.5 W (input: 100 / 240 V ac, output: No Load)

Output

Output voltage	12 V dc at 4 A
Output min. current	0 A
Line regulation	± 1%
Load regulation	± 5%
Over voltage protection	13.8 ~ 14.3 V dc max. (output shut down)
Short circuit protection	output shut down and auto restart
Ripple voltage	150 mV (p-p) (100~240 V ac at full load)
Efficiency	Energy Star compliant - level IV

Safety and EMI

HI-POT	input to output	3000 V ac at 10 mA for 1 min.
	input to ground	1500 V dc at 10 mA for 1 min.
Insulation resistance	input to output	> 100 M Ohm at 500 V dc
Safety approvals	UL/cUL, CE, GS	
EMI standard	meets FCC class B, CE, VCCI-II	
RoHS compliant	yes	
Leakage current	3.5 mA	

Environmental

Storage temperature	-10°C ~ +70° C
Operating temperature	0°C ~ +40° C
Storage humidity	10~90%
Operating humidity	20~80%



CUI INC

Part No: ETS120400UTC-P5P-SZ

Date: 6/07/2006

Unit: mm

Description: switching power supply

Page No: 2 of 7

Label

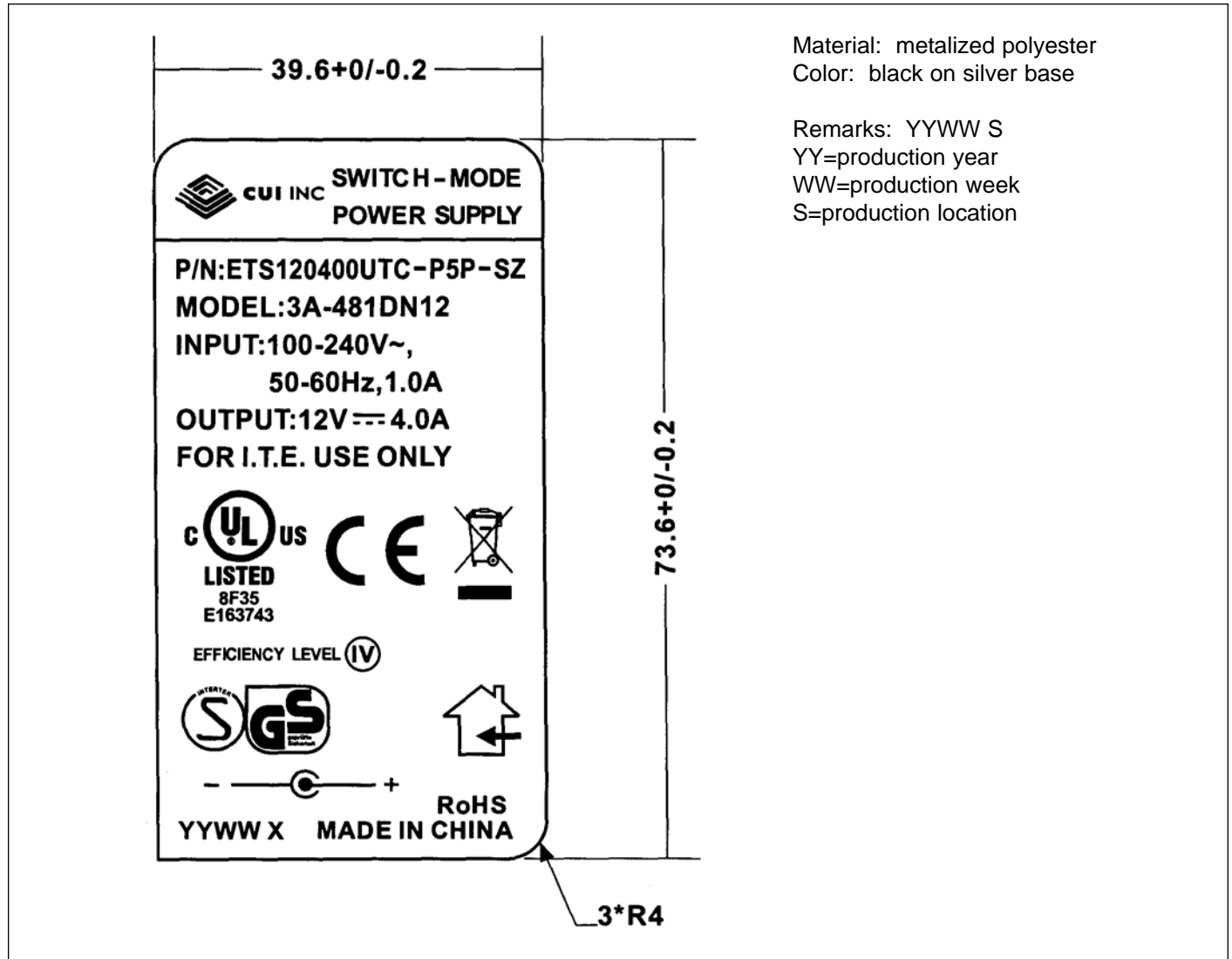



Mechanical Drawing

Tolerance: ± 1

Input plug	SC-14S-2PSV17C 3Pin
Weight	270 g
Case size	107.5 L x 56 W x 33.7 H mm

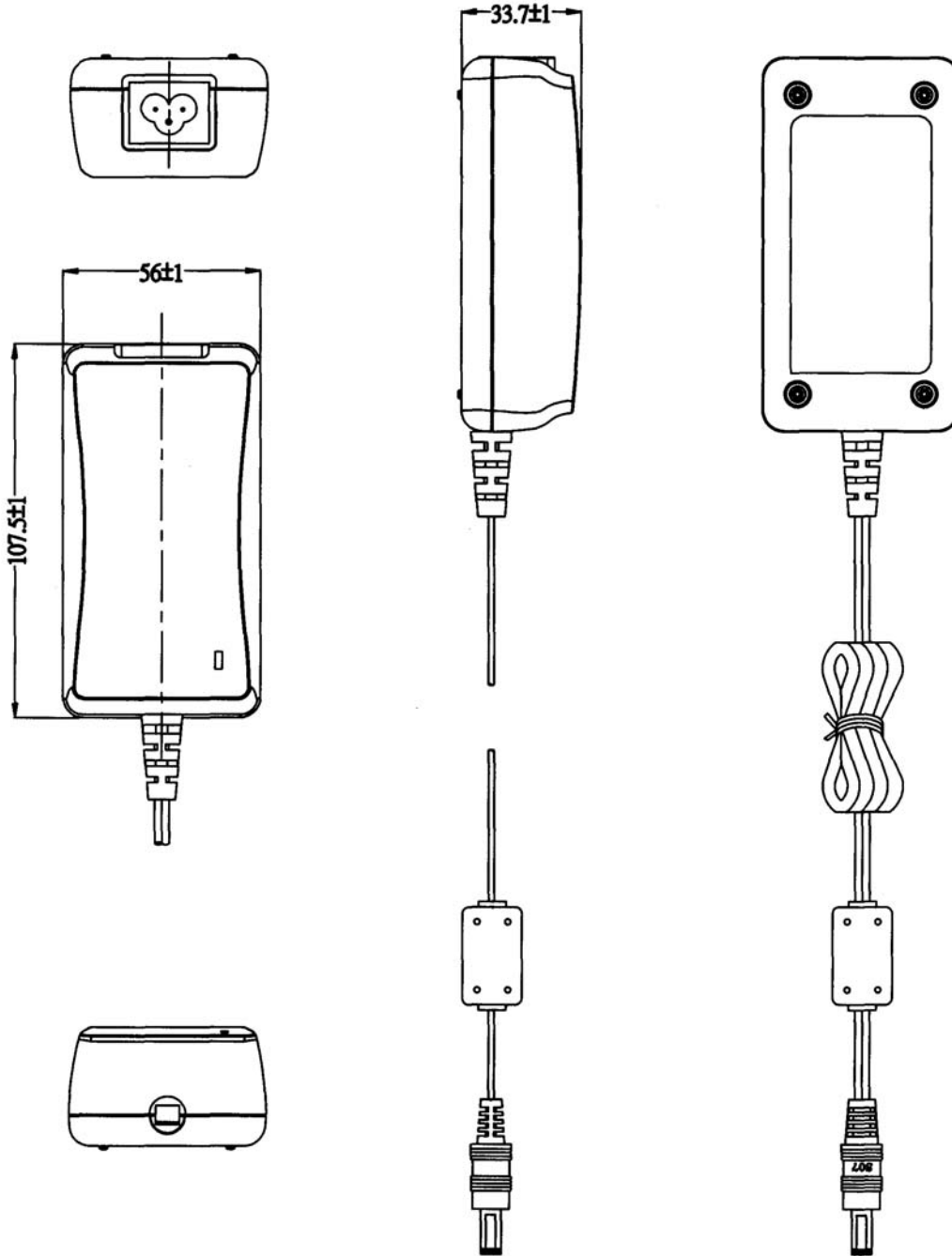



DC Cord

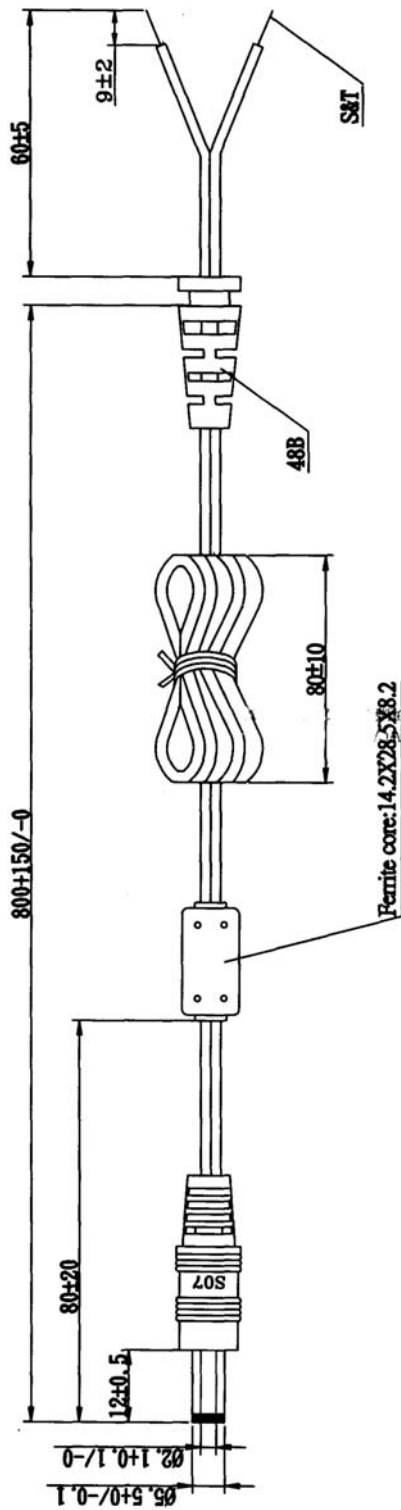

#18AWG X2C SPT-1 HAVE ON WORD WIRE IN OUTER, NO WORD WIRE IN INNER

Wire OD: Ø2.7X5.4



VIBRATION TEST	a. ±60°
	b. WEIGHT 200g
	c. 40 ROUNDMINUTE
	d. OVER 1000 COUNT MIN



CUI INC

Part No: ETS120400UTC-P5P-SZ

Description: switching power supply

Date: 6/07/2006

Unit: mm

Page No: 5 of 7

AC Cord

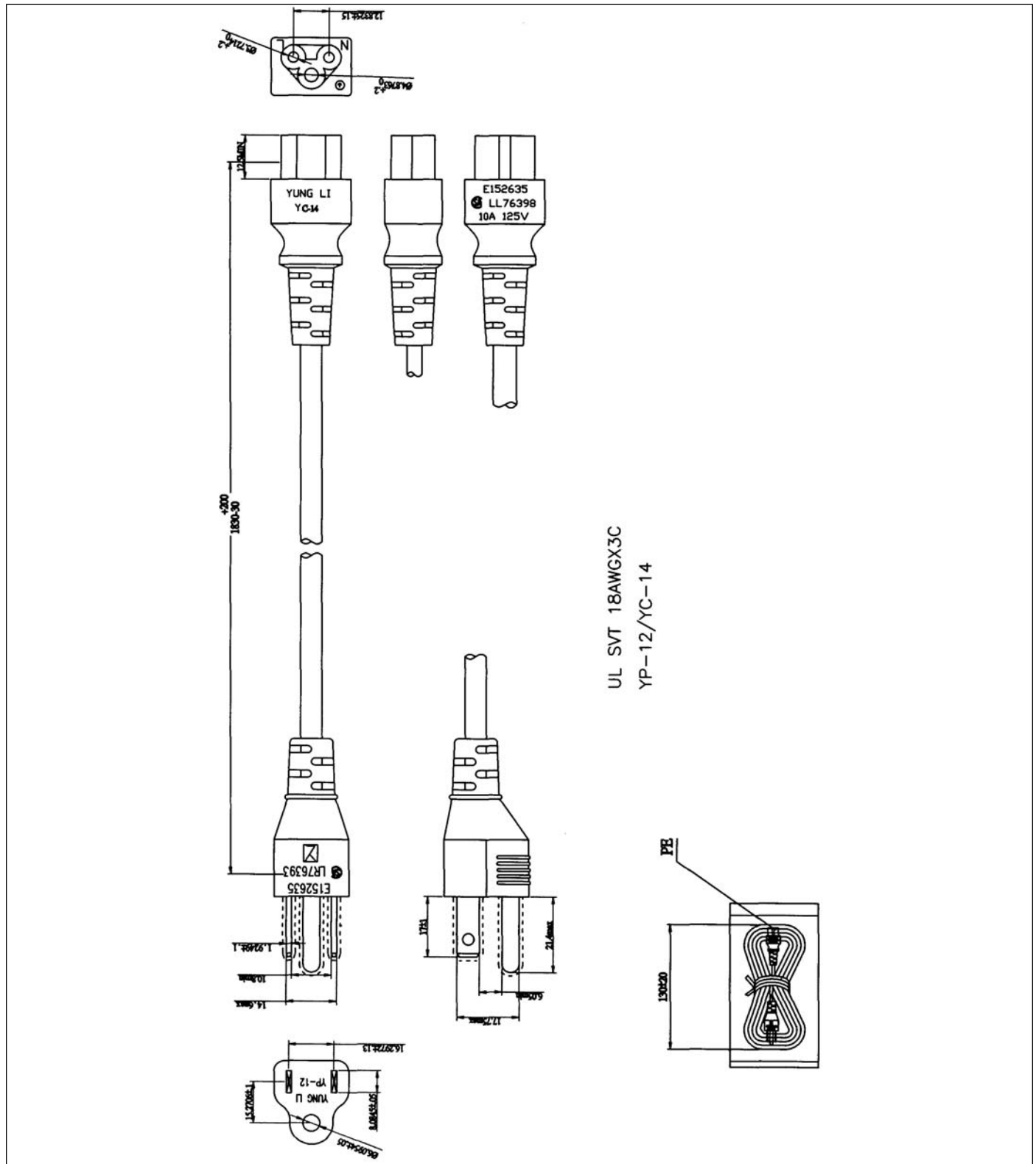



CUI INC

Part No: ETS120400UTC-P5P-SZ

Description: switching power supply

Date: 6/07/2006

Unit: mm

Page No: 6 of 7

Individual Packaging

Tolerance: ± 1

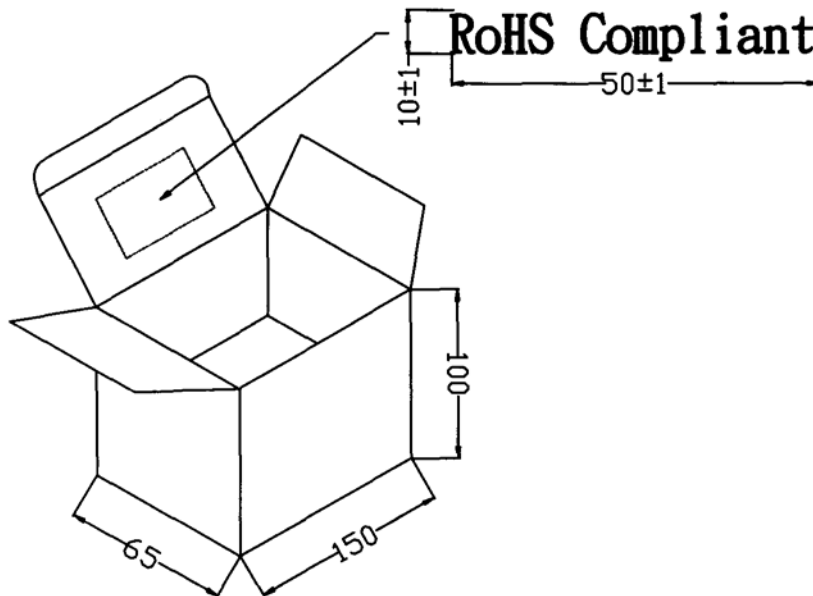
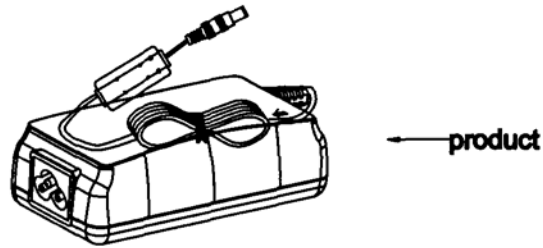
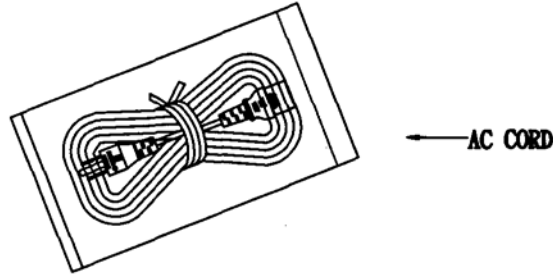



CUI INC

Part No: ETS120400UTC-P5P-SZ

Description: switching power supply

Date: 6/07/2006

Unit: mm

Page No: 7 of 7

Packaging

Tolerance: +7/-0

CARTON SIZE: 475X355X235mm

Q'TY: 30pcs(15x2x1)

N.W: 12.9KGS

G.W: 13.4KGS

G.W: 14.1KGS

"RoHS Compliant"

